

# EuQoS approach for resource allocation in Ethernet networks

Maxweel Silva Carmo<sup>\*†</sup>, Jorge Sa Silva and Edmundo Monteiro

*University of Coimbra, Pinhal de Marrocos, Polo II, Coimbra, Portugal*

## SUMMARY

Although the equipment currently available for Ethernet LANs provides basic quality of service (QoS) capabilities, as the ability of prioritizing traffic flows, it does not support more complex mechanisms like admission control or the ability of participating in a signalling process. This paper presents a survey on the QoS support and on resource allocation for LAN Ethernet networks, and describes a new proposal in the scope of the EuQoS project. The proposed solution is validated as proof of concept both by simulation and real testbeds. EuQoS is an FP6 IST Integrated Project with the aim of proposing, developing and studying end-to-end QoS support for Internet applications such as voice, video-conferencing, video-streaming and tele-engineering. Copyright © 2007 John Wiley & Sons, Ltd.

## 1. INTRODUCTION

Ethernet is a network technology supported by a set of international standards that offer pragmatic solutions for communication. Its success is due not only to its low cost but also to its simplicity.

Ethernet solutions are widely used in local area domains. However, with the development of Gigabit and 10 Gigabit variants, Ethernet seems to have gained a new momentum as a technology for use in all telecommunication networks. This, along with the fact that it is a flexible and switched technology, can be regarded as an omen of the success of Ethernet in future communication systems, especially when large networks are concerned. In fact, already today Ethernet is not only used in campus networks and LANs, but also in small office–home office (SOHO) networks, metropolitan area networks (MAN), wide area networks (WAN) and MAN residential scenarios (Ethernet passive optical networks, EPONs).

The rest of the paper is organized as follows: Section 2 presents a survey related to the support of QoS in LAN Ethernet networks; Section 3 introduces the EuQoS project and presents the proposed solution for resource allocation in Ethernet LANs; Section 4 discusses the validation of the solution and presents some evaluation results; and Section 5 concludes.

## 2. OVERVIEW OF THE QoS IN ETHERNET LANs

### 2.1 *The IEEE 802.1Q standard*

CSMA/CD is the media access control mechanism that was initially developed to give the possibility for two or more devices to share a common media. This mechanism worked well for 10 Mbps but revealed problems at higher data rates. Nowadays, CSMA/CD networks are hardly used. With the advent of full-duplex and switched solutions, it is possible to build collision-free tree and star topologies, connecting terminal equipment to switches.

Original Ethernet standards did not support QoS functionalities. IEEE 802.1Q [1] can be considered a first step in this direction, by defining the operation of virtual LAN (VLAN) bridges. The standard adds

---

\*Correspondence to: Maxweel Silva Carmo, University of Coimbra, Pinhal de Marrocos, Polo II, Coimbra, Portugal

†E-mail: maxweel@dei.uc.pt

an extra 4-byte tag in the MAC header (Figure 1) that is used for both VLAN operation and QoS priority identification. The first 2 bytes (TPID) of the tag is used to identify an 802.1Q frame (all 802.1Q frames have this field set to 0x8100). The next two bytes consist of three fields: a canonical format indicator (CFI), a VLAN field, and a 3-bit length field used to differentiate the priority of packets.

The IEEE 802.1p standard (which is part of IEEE 802.1D [2]) supports the provisioning of expedited traffic in a LAN network, based on the use of VLAN tags. VLAN tags have two parts: the VLAN ID (12-bit) and the prioritization field (3-bit). IEEE 802.1p defines this latter field, allowing the prioritization of traffic into eight levels, and thus providing the basic support for QoS differentiation in Ethernet.

The user priority values, defined in the IEEE 802.1p standard, are presented in Table 1. Each level is associated with a specific traffic type.

2.2 Rationale for QoS in Ethernet

It is important to distinguish the use and the need of QoS mechanisms in the different types of Ethernet networks. Although the technology principles are the same, the purpose of implementing QoS policies can be different.

A SOHO, also called a *virtual office*, refers to the small office or home environment, and the business culture that surrounds it. In this type of environment, the implementation of QoS mechanisms in order to differentiate traffic inside the network is not critical, as the number of active pieces of equipment is generally low.

Ethernet has found widespread acceptability in campus and small-scale environments, and nowadays is the supporting technology of most LANs. With the use of different applications, with a wide range of requirements, it is crucial to differentiate the traffic and to manage it properly.

Current MAN infrastructures are built not only for a voice-centric world but also for a data-centric world. However, in order to use Ethernet to implement MANs, it is necessary to offer and maintain the

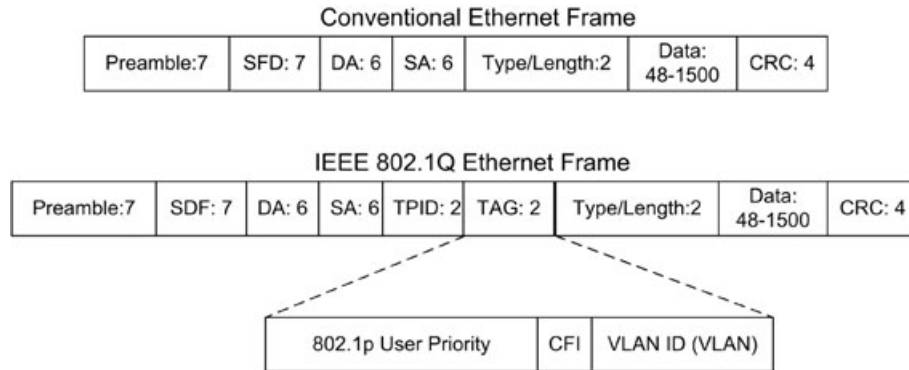

Figure 1. IEEE 802.1Q frame

IEEE 802.1p User priority	Traffic type
7 (highest)	Network management
6	Voice
5	Video
4	Controlled load
3	Excellent effort
0	Best effort
2	Undefined
1 (lowest)	Background

Table 1. IEEE 802.1p user priority value recommendations

same level of QoS of traditional voice-based applications. The use of over-provisioned solutions, typical in some of the recent systems, leads to low resource utilization, high costs and poor scalability.

The main reason Ethernet is being considered in WANs is because of its low cost. Initially, Ethernet will be used as a switch-to-switch interconnection for multiplexing different traffic, offering inter-operation between different vendors' implementations. The definition of new standards and policies is crucial to the mapping of traffic classes between different operators.

The high modularity and scalability of Ethernet solutions enables operators to supply broadband services to subscribers, including data, voice and video, through a cost-effective architecture in residential networks, namely through the use of EPONs. However, in these networks, each link supports a set of subscribers, which produce very bursty traffic in contrast to MANs and WANs, where the bandwidth requirements are relatively smooth due to the aggregation of many traffic sources.

Given the variety of environments to which Ethernet is applicable, which nowadays covers the whole spectrum of networks, it is clear that if quality of service is to be provided to applications it must be supported in this type of technology.

### 3. THE EuQoS SYSTEM

EuQoS [3] is an FP6 IST Integrated Project with the aim of proposing, developing and studying end-to-end QoS support for Internet applications. This will be achieved through the research, integration, testing, validation and demonstration of end-to-end QoS technologies that can support advanced QoS-demanding applications such as voice, video-conferencing, video-streaming, educational, tele-engineering and medical applications.

#### 3.1 General architecture

EuQoS targets a wide range of network technologies, from access networks—including Ethernet, UMTS, and WiFi—to core networks. As such, one of the research lines of the EuQoS project consists of the development of solutions that provide QoS in Ethernet networks.

The EuQoS system consists of two major research components: user and QoS-aware Control Plane and QoS Protocol Stack, as shown in Figure 2. The QoS Protocol Stack will result in a new API over existing and new transport protocols that will provide variable levels of order and reliability.

The Control Plane will include a set of functions that might be supported in network elements such as routers and in end systems. To integrate the Control Plane of the EuQoS architecture six main functions were identified:

- *Function 1:* signalling and service negotiation (SSN);
- *Function 2:* connection admission control (CAC);
- *Function 3:* monitoring measurement, fault management (MMFM);
- *Function 4:* traffic engineering and resource optimization (TERO);
- *Function 5:* security and AAA (SAAA);
- *Function 6:* charging (CHAR).

A simplified network model of the EuQoS project is presented in Figure 3. A traffic flow starts from an access network (AN), crosses the core boundaries and ends on another access network. In the EuQoS system the AN conveys any of the following networking technologies: WiFi, UMTS, Ethernet and xDSL. Also, a traffic flow is defined in terms of source and destination IP, source and destination port, and protocol (i.e., UDP, TCP).

The QoS for a session is ensured through a process of signalling and resource reservation along the path between the end points. After the session ends, the EuQoS system starts to release the resources previously configured by contacting again the different network entities along the path.

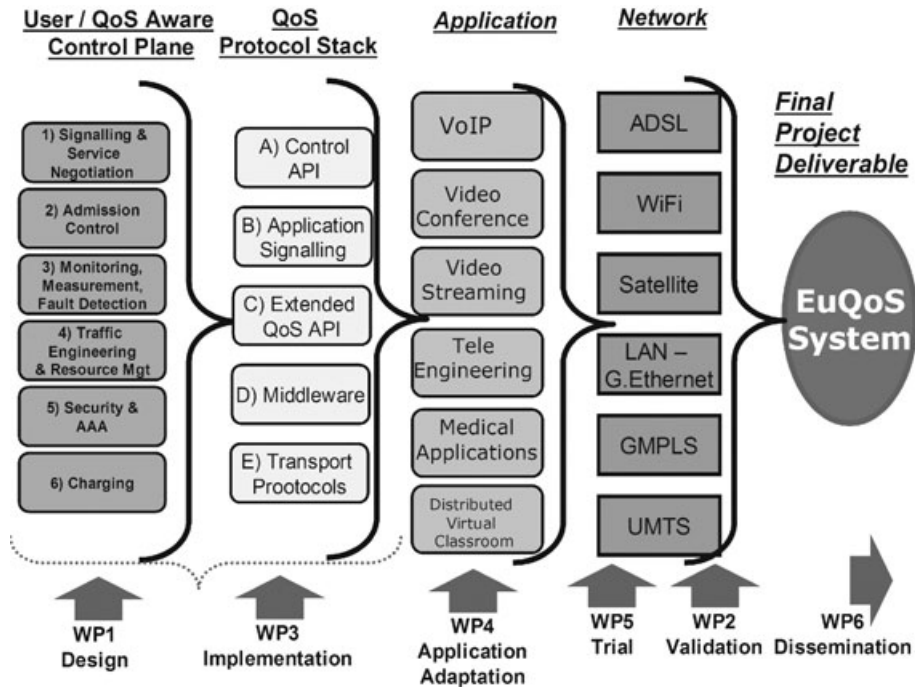

Figure 2. The EuQoS system

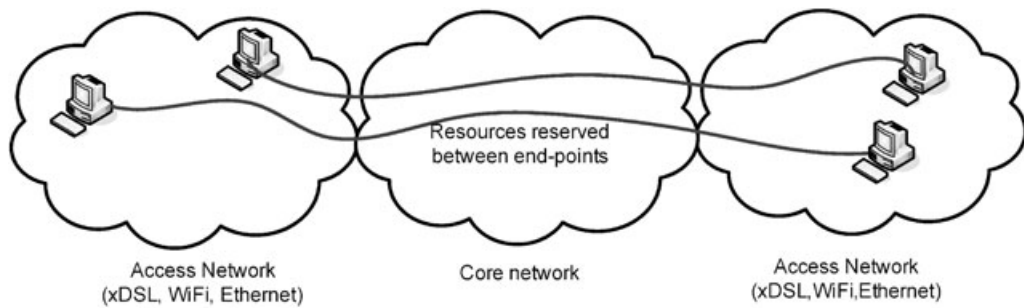

Figure 3. EuQoS system network model

In the EuQoS system the user/application can choose amongst different QoS Class of Services (CoS) according to how much he/she wants to pay or according to the application requirements. The CoSs support the limit values for the following parameters: IP packet loss rate (IPLR), IP packet transfer delay, and IP delay variation (jitter). Table 2 presents the definition of three CoSs used in the EuQoS project.

The CoSs supported by EuQoS system on different networks are still under specification.

### 3.2 RA subsystem architecture

A general architecture aimed at supporting the resource reservation processes on the ANs has been specified (Figure 4).

The internal architecture of the RA consists of the following sub-modules:

- *RA-SSN*, which is the interface between the RA module and the remaining EuQoS system. It receives the resource reservation request and forwards it to the *RA controller* sub-module. It is also responsible for security aspects such as the authentication of the requester;

Types of classes of services	QoS objectives		
	IPLR	Mean IPTD	IPDV
Real time (RT)	10 <sup>-3</sup>	100 ms	50 ms
Non-real time (NRT)	10 <sup>-3</sup>	1s	50 ms
Best effort (BE)	U	U	U

Table 2. Class of Services definition

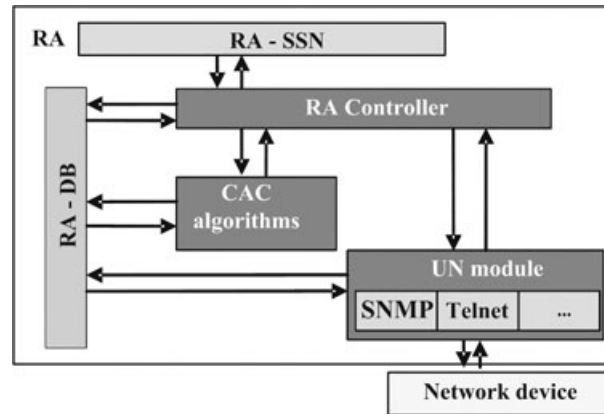

Figure 4. RA general architecture

- *RA controller*, which is responsible for handling all operations inside the RA. It receives requests from the EuQoS system (via RA-SSN) and initiates appropriate actions inside the RA;
- *CAC algorithms*, which decide about acceptance/rejection of a new session during the invocation process. Additionally, this module updates information about reserved and released resources in the RA-DB. In the general case, we need separate CAC algorithms modules for each CoS and for each underlying network technology (e.g., WiFi, LAN/Ethernet, inter-domain link);
- *RA-DB*, which is a database for storing internal data managed by the RA sub-modules. The stored data include (1) information about available and currently used resources, which is needed for performing the CAC function, (2) information about currently running sessions, and (3) device-specific information related to current configuration of equipment;
- *UN module*, which is responsible for sending configuration commands to the network devices. For that, it can use different interfaces and protocols (e.g., telnet to the management console, SNMP, COPS), depending on the capabilities of the given device.

### 3.3 The RA Ethernet

#### 3.3.1 Design issues

In the context of the EuQoS we distinguished between two LAN scenarios, according to their ability to classify EuQoS traffic: LANs that employ switches capable of identifying and prioritizing EuQoS traffic (source, destination IP, source, destination port, and protocol); and LANs where switches fail to accomplish these tasks. The first type of switch allows a more precise packet control, but is more expensive.

The RA Ethernet module is aimed at working on a switched full-duplex Ethernet LAN and its development was driven to address the resource reservation problems in the two kinds of networks, described below in more detail.

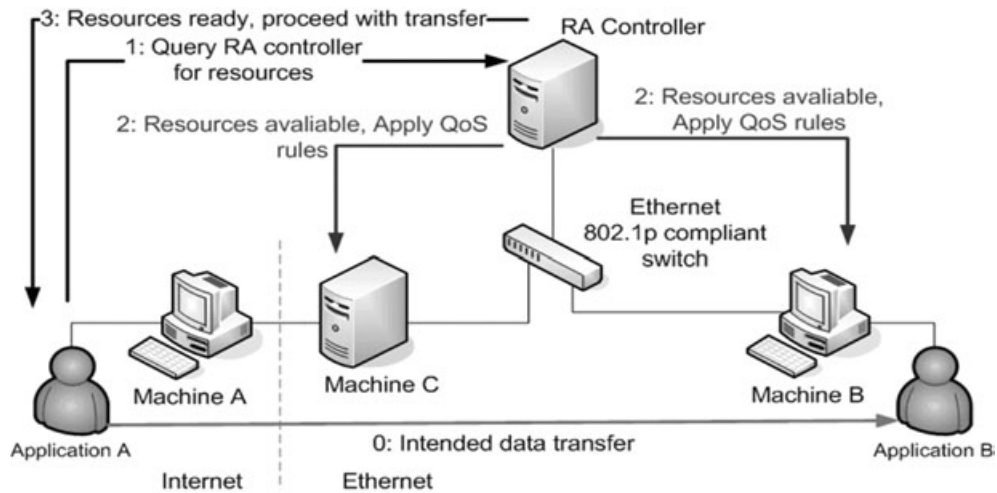

Figure 5. EuQoS resource reservation on switches that do not directly support EuQoS traffic

### 3.3.1.1 Non-EuQoS-aware LAN scenario

For LANs that are not able to identify the EuQoS traffic, an additional mechanism is necessary to perform the packet classification before the traffic reaches the switch. In this way, the first attempt to develop the RA modules for this scenario was aimed at widespread compatibility by using the well-known 802.1p VLAN priority bits. The goal was to mark (classify) Ethernet frames according to the IP and TCP/UDP parameters.

The first tool proposed to handle these Ethernet frame bits was *ebtables*. With its simple '*iptables*-like' tables, chains, and rules the process seemed an easy task, requiring only a simple system call to add a prioritization rule and another to remove it. But, since *ebtables* cannot mangle VLAN 802.1p priority bits, but only verify them for a match, it could not be used.

The solution chosen was to use the TOS/DSCP layer 3 priority bits. Assuming that no other layer 3 protocols (such as IPX) are being used and that an increasing number of switches support DSCP-based packet prioritization, there is no problem with this decision. It relies on the same principles as the original concept, except that both the matching process and mangling process occur on the same layer (unlike previously, where the matching occurred on layer 3 and mangling occurred on layer 2). The advantage of this concept is that it can be done via *iptables*, where TOS/DSCP bit mangling is supported. This scenario is illustrated in Figure 5.

Let us assume that an application in machine A wants to initiate a TCP data transfer to another application residing in machine B, with highest priority, on port 10001. In this scenario, the resource reservation process will be composed of the following steps:

- The application in machine A sends a request to the RA Controller asking for resource allocation.
- The RA controller replies positively, meaning that resources are available.
- The RA controller contacts machines C and B and instructs them to add a rule to their routing table.
- Both machines add a rule to mark all IP packets with the highest priority, whose layers 3 and 4 fields match the following: source IP (machine A), destination IP (machine B), destination and destination port 10001, and TCP protocol.

Since the switch respects the priority bits correctly, this flow will have top priority inside the LAN network.

In a scenario where there is more than one switch between the two endpoints, all the interconnecting hardware would need to perform DSCP prioritization as well.

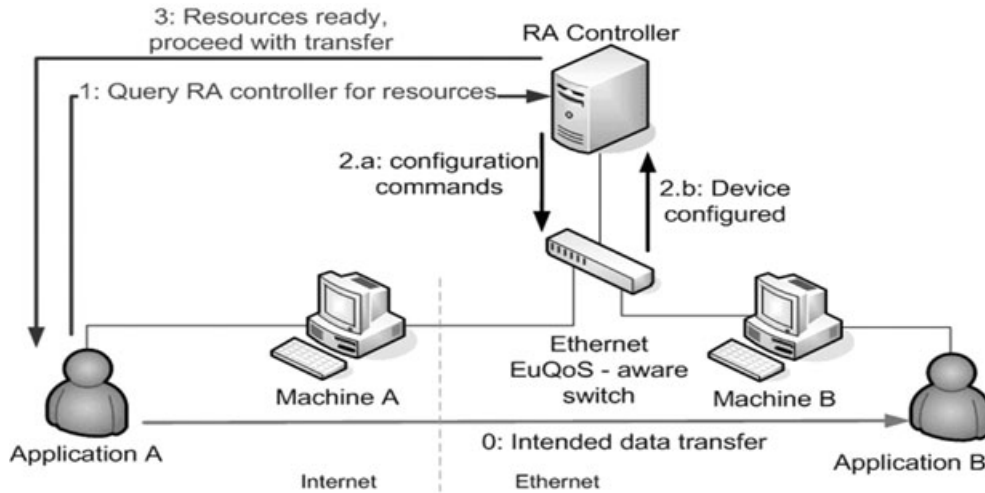

Figure 6. Resource reservation process on switches that support EuQoS traffic

To avoid prioritized but non-authorized packets of reaching the switch, machine C can be configured to re-mark all non-EuQoS packets to a default low priority level.

Although this solution is easy to implement, not expensive and generic enough for widespread implementation, it can reduce network performance due to the bottleneck imposed by the classification node (machine C).

### 3.3.1.2. EuQoS-aware LAN scenario

Since the switches in this case can identify EuQoS traffic flows, implementation of the RA becomes simpler and more effective than in the previous case. In order to allocate resources, the RA module just needs to contact the switch and perform the right configuration. As the switch normally does not support a high-level protocol as SNMP to perform this sort of configuration, the RA, through the UN module, needs to contact the switch via a more general protocol like telnet or SSH. This description is presented in Figure 6.

Since this solution relies on the capability of the switch to identify traffic flows, there is no need for additional computers for packet marking, increasing the overall performance of the LAN.

### 3.3.2 The RA-CAC module

On the EuQoS system a given access network can be configured to share the resources (i.e., bandwidth) among the different CoSs. For instance, the RT CoS could be allowed to use 50% of the total bandwidth, while the NRT could use 20%.

To perform the reserve of resources for an application, the EuQoS system, through the RA-SSN interface, sends to the CAC module some traffic parameters like the peak bit rate ( $pbr$ ) and the desired CoS. The algorithm checks if it is possible to allocate this resource (based on  $pbr$ ), taking into account the already allocated bandwidth for the required CoS.

The algorithm can be described as follows: let be  $p$  the maximum bandwidth allowed for a given CoS and  $r$  the  $pbr$  of a traffic flow. The resource for the  $n$ th traffic flow will be granted only if

$$\sum_{i=1}^{i=n} r_i \leq p$$

If the flow is allowed, its parameters (source, destination ip, etc.) will be forwarded to the UN module to configure the necessary devices. Otherwise, the CAC will return a denying message to the EuQoS system.

### 3.3.3 The RA database

The RA-DB stores network information used by the CAC to correctly perform the admission control activities. Basically, the data held by the RA-DB can be grouped as follows:

- *Provisioning*: Information that characterizes the provisioning of the LAN is stored in the following way: (CoS, Percentage). The CoS corresponds to a class of service specified in Section 2.1 and the percentage refers to the amount of the link bandwidth that is dedicated to it. For instance, in a LAN operating at 100 Mb the NRT class set at 40% means that the CAC will allow NRT flows until the sum of their bit rate reaches 40Mb. The limits for each CoS can be configured manually by the administrator or signalled by upper layers of the EuQoS system. In the latter, the RA controller is responsible for processing the provisioning request and updating the RA-DB.
- *Topology*: All relevant information, such as the bandwidth capacity of the links, the addresses, and location of the configurable devices, are stored as part of the topology.
- *Traffic flow*: The CAC maintains a track of the flows currently accepted by storing their information on the RA-DB. This is necessary for further reference, when the flow is released.

### 3.3.4 The RA-UN module

The UN module is the component of the RA architecture responsible for the effective allocation of the LAN resources. It is responsible for communication with the CAC module and for contacting the respective network equipments to effectively allocate the resources. Currently, it has only been implemented and tested under Linux, but should work on most UNIX flavors.

The way the UN module works varies according to the employed scenario. In the non-EuQoS-aware case, after receiving the resource reservation request from the CAC layer it creates the appropriate *iptables* rules based on the stream parameters and QoS properties of the application that requested the reservation. Next, it contacts the appropriate computer and sends them the rules. If the reservation is somehow not possible, the server returns an error code, so that the remote UN module can proceed to roll back the changes made so far. When successfully executed on the remote computer, the rules will mangle all packets of the referred stream, causing their TOS/DSCP bits to be changed. In this way, the classification of the packets takes place on the network borders, leaving the network hardware (i.e., switches) with the sole task of prioritizing the traffic according to the DSCP values of the packets.

On the EuQoS-aware scenario, the UN module does not need to configure other computers on the network. Instead, it is coded in a way that is possible to contact and configure the switch using a general protocol like telnet, SSH or SNMP. Naturally, this implementation changes according to the employed switch.

After successfully configuring a remote computer or switch, the UN module stores its information in the RA-DB for later use when releasing the resources.

## 4. TEST PROCEDURES AND RESULTS

To validate the solutions proposed above, we considered both the use of the NS-2 [4] simulation tool and a specific testbed capable of representing real scenarios.

### 4.1 Measured parameters

To evaluate the capabilities of the solution to guarantee resources for the EuQoS applications the following parameters were measured: OWD, IPDV, and IP packet loss. A brief explanation of these is described below:

- *One-way delay (OWD)*: Although a number of delay metrics exist (e.g., the round trip delay [5] and mean delay metric), this paper uses the OWD. It can be defined as the time occurring from the packet generation at the sender and the time of its reception at the receiver.



- *IP packet delay variation (IPDV)*: The difference between the OWD of the former and the arriving packet.
- *Packet losses*: These can be represented by the one-way packet loss metric [6]. This metric is measured per packet and is set to 0 when the packet sent by the source node reaches the destination node within a reasonable period of time. Otherwise, it is set to 1.

#### 4.2 Simulation

Although the NS-2 tool offers support to the simulation of Ethernet networks, it does not implement the 802.1Q and 802.1p standards.

To allow for the simulation of QoS in Ethernet networks, we developed a new specific queue object that implements the recommendations of the IEEE 802.1p standard related to traffic prioritization [7]. Basically, the queue presents the following properties:

- It can be configured to use up to eight virtual queues to group incoming LAN packets into separate traffic classes according to IEEE 802.1p recommendations.
- The forwarding mechanism is implemented in such a way that packets from a given queue are selected for transmission only if a higher-order queue is empty at the time of selection (Figure 7).

The implementation of the IEEE 802.1p here described is intended to run on a scenario of switched Ethernet networks with full-duplex connections.

Figure 8 presents the LAN used on the simulation. It is worth remarking that at the time this paper was written the built simulation scenario was very similar to the topology used in the real testbed (see Figure 10). More complex scenarios reflecting the end-to-end EuQoS network model were also studied. Such a scenario is illustrated in Figure 9 and shows both the access network of the sender and receiver, in addition to the core network connecting them.

Three kinds of traffic were used to perform the simulation: Video-conferencing (videocall), VoIP, and Video on Demand (VoD). Table 3 gives a detailed description of these traffic types. The ITU-T recommendations, concerned with the one-way delay, packet loss and jitter of each type of flow, are also presented.

Unidirectional video call, VoIP, and VoD flows were set between hosts connected to different switches. Two different classes of services were used. The video call and VoIP traffic flows were set with the highest priority value (RT) and the VoD traffic was set with a lowest one (BE), acting as background traffic.

The simulation tests involved incrementing the number of traffic flows along the simulation and analyzing the OWD, IPDV, and packet loss of each traffic type (videocall, VoIP, and VoD).

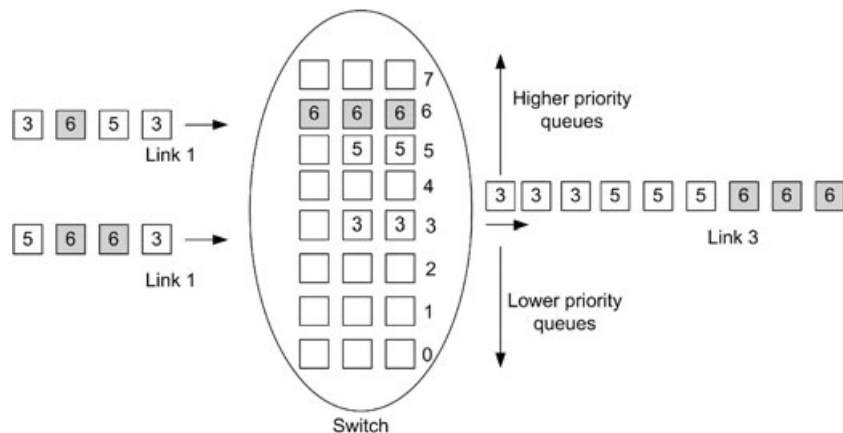

Figure 7. Strict priority scheduler

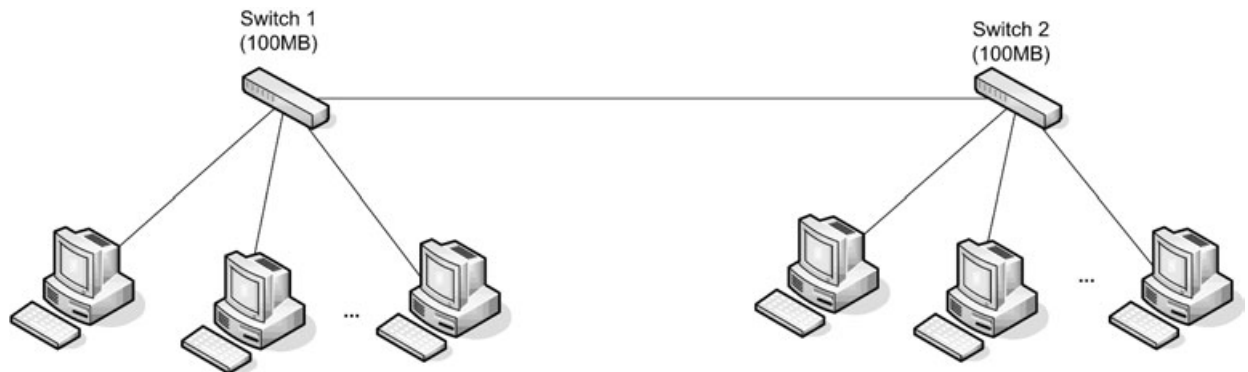

Figure 8. Simulation scenario

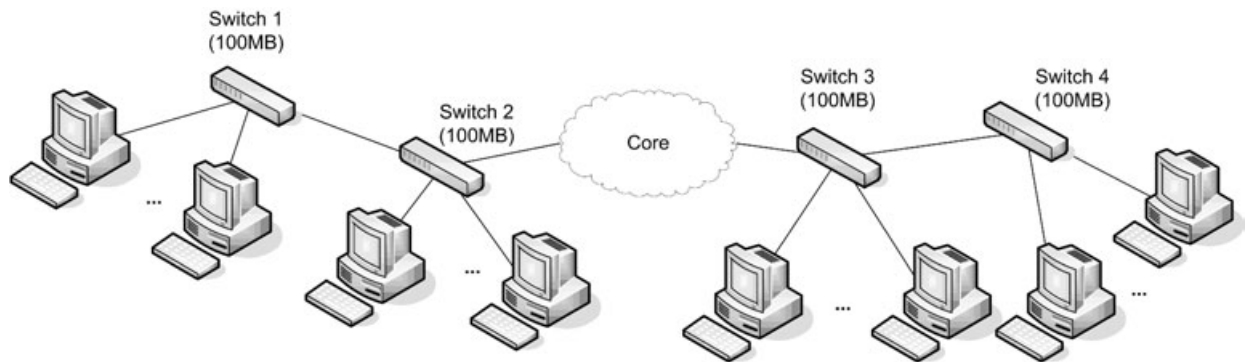

Figure 9. An end-to-end simulation scenario

Traffic type	Description	ITU-T recommendations
VideoCall	VideoCall	$E[OWD] < 400 \text{ ms}$ $OWPL < 0.001$ $IPDV < 50 \text{ ms}$
VoIP	Codec = G.711 Rate = 64 kbps Arrival pattern = ON/OFF $E[ON] = 1.58 \text{ s}$ $E[OFF] = 0.87 \text{ s}$ Frame size = 160 bytes Frame rate = 50 fps	$E[OWD] < 100 \text{ ms}$ $OWPL < 0.001$ $IPDV < 50 \text{ ms}$
VoD	Mean rate = 0.77 Mbps Peak rate = 3.3 Mbps Frame rate = 25 fps Min. frame size = 72 bytes Mean frame size = 3800 bytes Max. frame size = 16475 bytes	$OWPL < 0.001$ $IPDV < 50 \text{ ms}$

Table 3. Traffic description

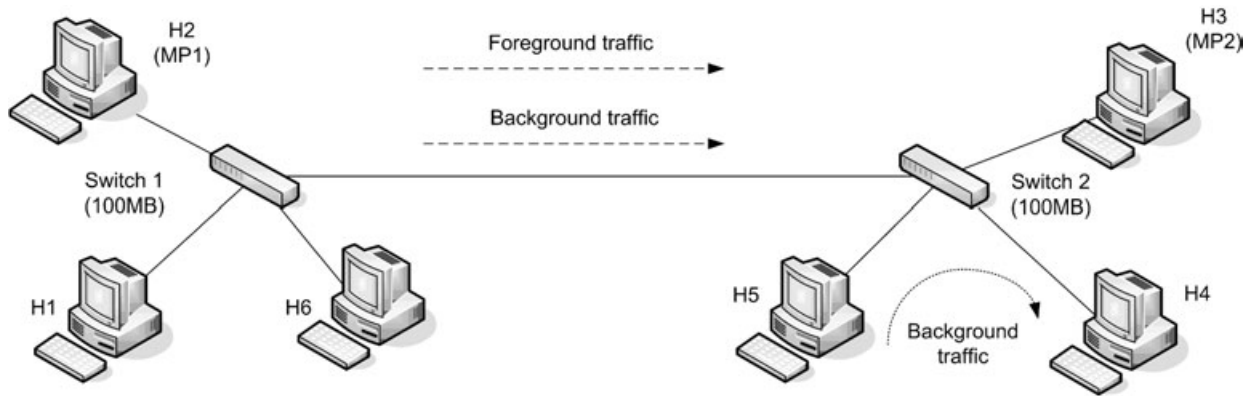

Figure 10. Testbed scenario

### 4.3 Testbed

The Ethernet topology conceived for the testbed is presented on Figure 10. The switches connect the hosts, through full-duplex 100 Mbps links, and are configured with a strict priority scheduler with eight queues to forward the flow packets according to their QoS requirements. The switch model employed on the testbed is a 3Com 5500 EI (100MB). Besides being IEEE 802.1p compatible, this switch is also capable of identifying flows based on IP addresses, service ports, and protocol (UDP or TCP).

The activities of the switch regarding forwarding of EuQoS traffic can be divided into three major steps: after (1) identifying the traffic flow the switch (2) marks its packets with the 802.1p values that reflect the CoS required by the flow; next, (3) the packets will be routed to one of the eight queues according to their priorities.

Thus, the testbed follows the EuQoS-aware scenario and the UN module communicates with the switches via SSH protocol, whenever a reservation or release of resources is needed.

A pair of hosts connected through different switches is allocated to handle the foreground traffic and to take the network measures using the appropriate tools such as Netmeter and Chariot. Other host pairs are employed to generate and receive the background traffic.

As the link between switch 1 and switch 2 represents a bottleneck, sufficient traffic flows are transmitted from hosts attached to switch 1 to hosts attached to another one to ensure heavy traffic conditions on the link. In addition, host H5 is used to send traffic to a receiver also connected to switch 2 as a method to have different traffic conditions (i.e., buffer occupancy) on the switches.

The scenario represents a simplification of common bandwidth configurations used in Ethernet networks today. Also, assuming that a well-planned/provisioned LAN network will have similar levels of load conditions along its topology, we can analyze only a small portion of the network instead of the entire one.

The Netmeter tool was used at host H2 (Figure 10) to generate a G.711 VoIP traffic flow and at host H3 to take the packet measures (one-way delay, jitter, etc.). The Mgen traffic generator was used to overload the network with background traffic. Also, to take measures like one-way delay and jitter it is necessary to synchronize the computers involved. Synchronization between H2 and H3 was made through the NTP applications installed on each one.

### 4.4 Results

#### 4.4.1 Simulation

Figure 11 shows the OWD of the three traffic types. As expected, when networks become overloaded the delay in VoD traffic increases steadily.

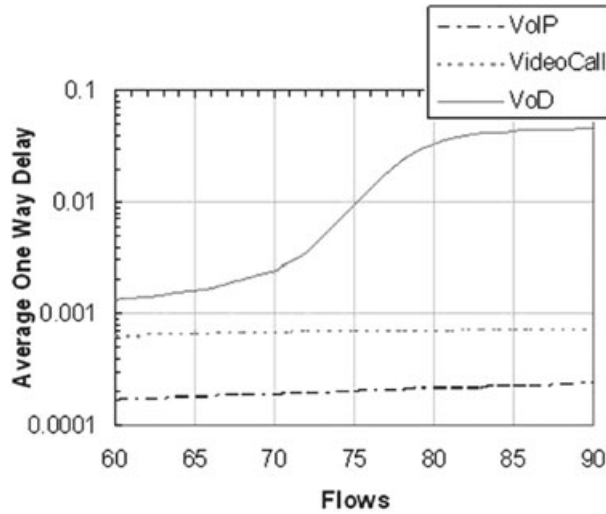

Figure 11. One-way delay

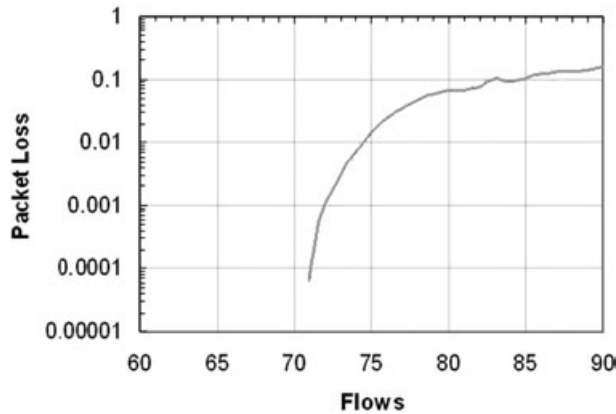

Figure 12. VoD packet loss

Figure 12 presents the packet loss rate for VoD traffic flows. As there were no losses for RT traffic (VoIP and videocall) they are not depicted.

As shown in Figure 13, the IPDV of the videoCall and VoIP suffer small variations during the whole the simulation time.

4.4.2 Testbed

The results presented below are intended to make a performance comparison of the network with and without RA Ethernet. Although just OWD was taken as a reference, the IPDV and packet losses measures could also be taken as well.

Figure 14 presents the OWD for VoIP flow along the simulation time when no resource reservation request is sent to the RA Ethernet module. As expected, when the LAN becomes overloaded the OWD increases considerably and even packet losses occur.

Figure 15 presents the OWD for VoIP packets after the RA module has performed the reservation, associating it with the higher-priority queue. During periods of high congestion only a small increase in the delay is observed.

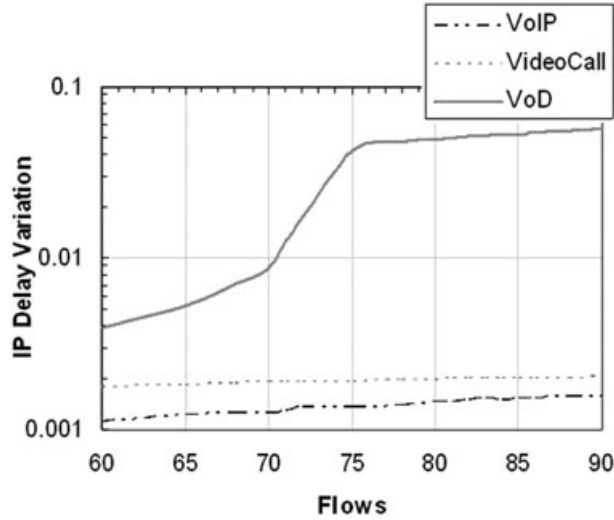

Figure 13. IP delay variation

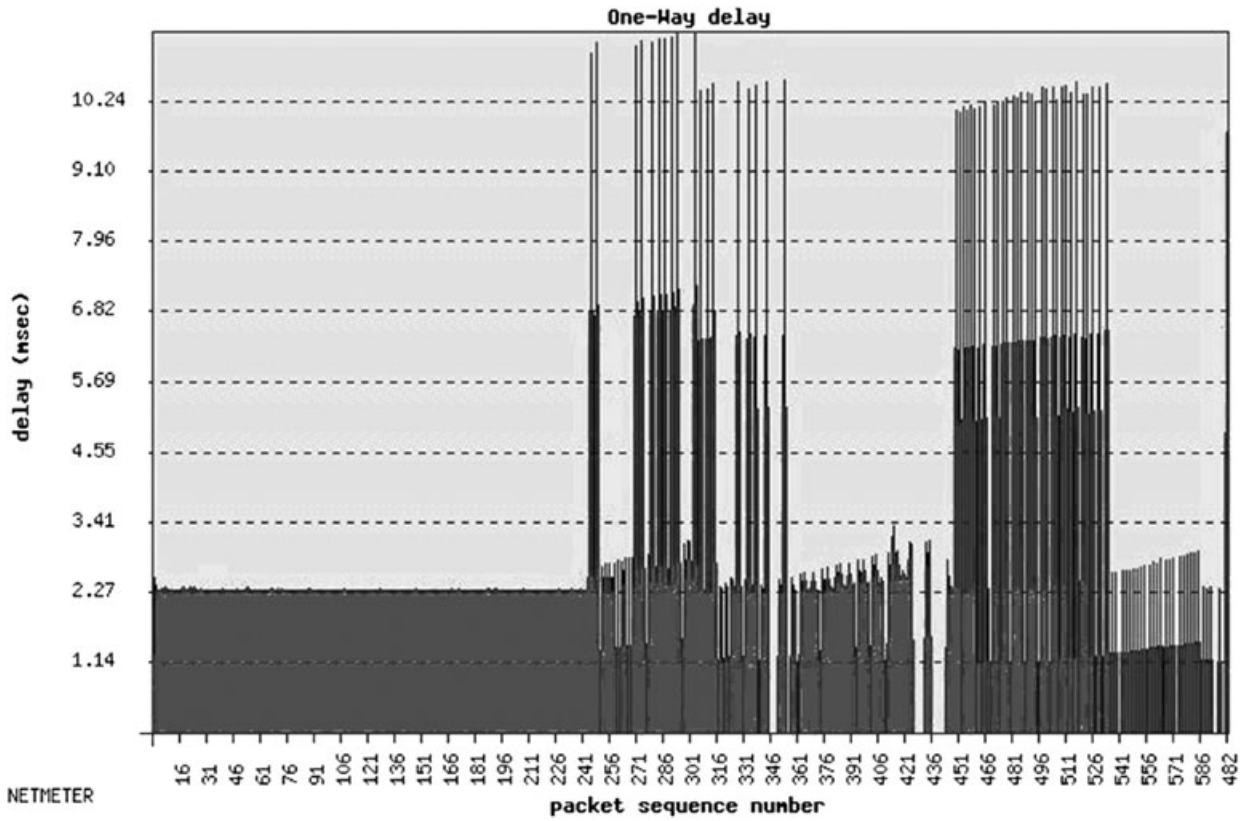

Figure 14. One-way delay of VoIP flow where no prioritization was used

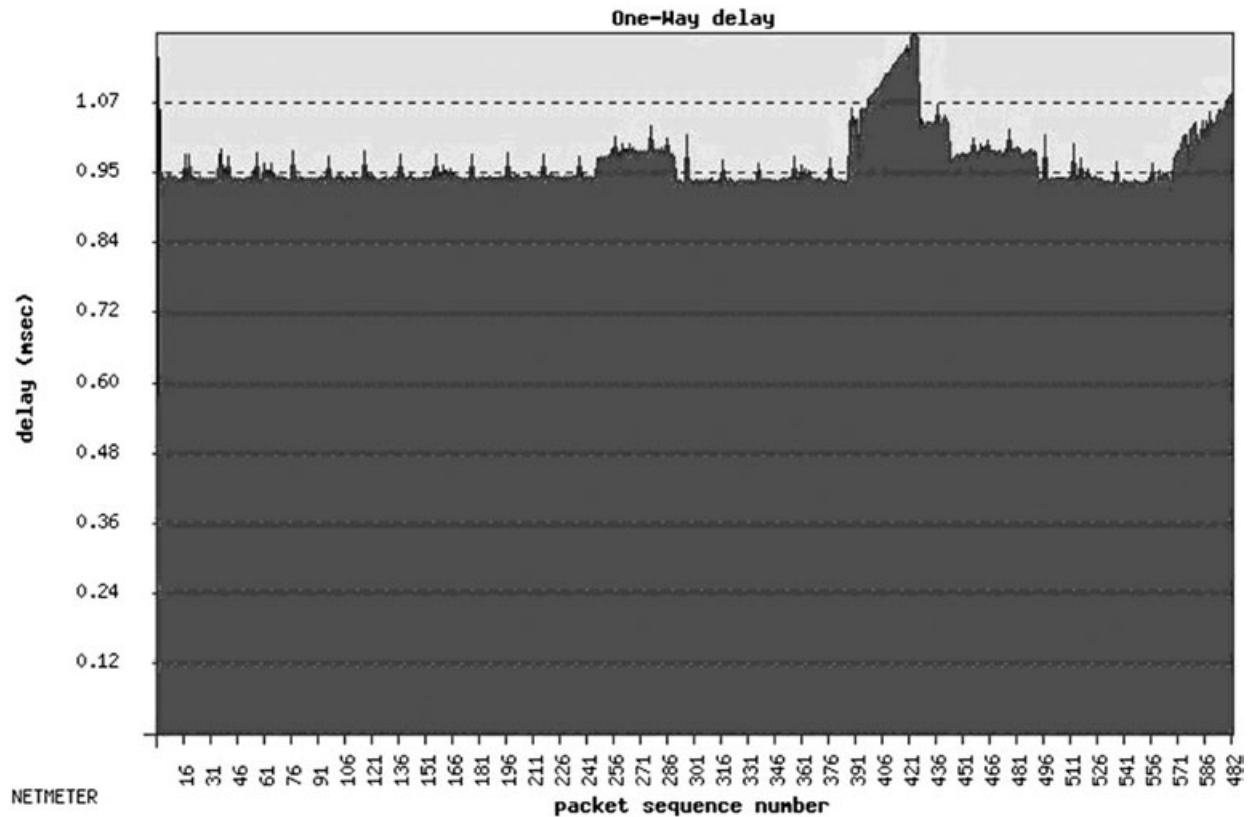

Figure 15. One-way delay of VoIP flow where traffic prioritization was employed

#### 4.5 Analyses of the proposed models

As stated in Section 3, the CAC decision is taken in an isolated way by a particular network node. As the dimension of a LAN network is smaller than a WAN, or even a MAN scenario, the solution scales. On the other hand, the centralized nature of the CAC represents some drawbacks. Firstly, it represents a single point of failure. If the node hosting the CAC fails, the network will not be able to handle the EuQoS traffic at all. To walk-through the problem, redundant CACs should be necessary at other points of the LAN, demanding a sort of communication mechanism to keep them aware of who is going to take care of the admissions and to share the RA-DB. Secondly, the centralized CAC needs to be aware of both the EuQoS flows that cross the LAN and other local traffic that uses a high-priority service. In a centralized model the latter can be more difficult for the CAC to detect. For instance, Figure 16 presents a scenario where the CAC is not aware of the local traffic between C and D, which can influence forwarding of the EuQoS packets by the switches S2 and S3. Considering that the switches implement strict priority queues, if the local flow has at least the same priority as the EuQoS traffic the latter can suffer considerable disturbance.

To avoid this situation, some solutions are being studied according to switch capability. For the EuQoS-aware scenario, switches can be dynamically configured to re-mark the local traffic with a lower priority (best effort, for instance) to avoid the unauthorized use of resources. In this way, the local traffic of Figure 16 should be remarked when reaching switch S2.

For the non-EuQoS-aware scenario, the solutions are more complex and can impose different restrictions on the network. Although a number of low-cost switches allow the re-marking of packets, it would be a challenge for them to identify the local traffic, since the re-marking is generally based on coarse-grain parameters like the switch's port number by which the packet comes or is forwarded. Another

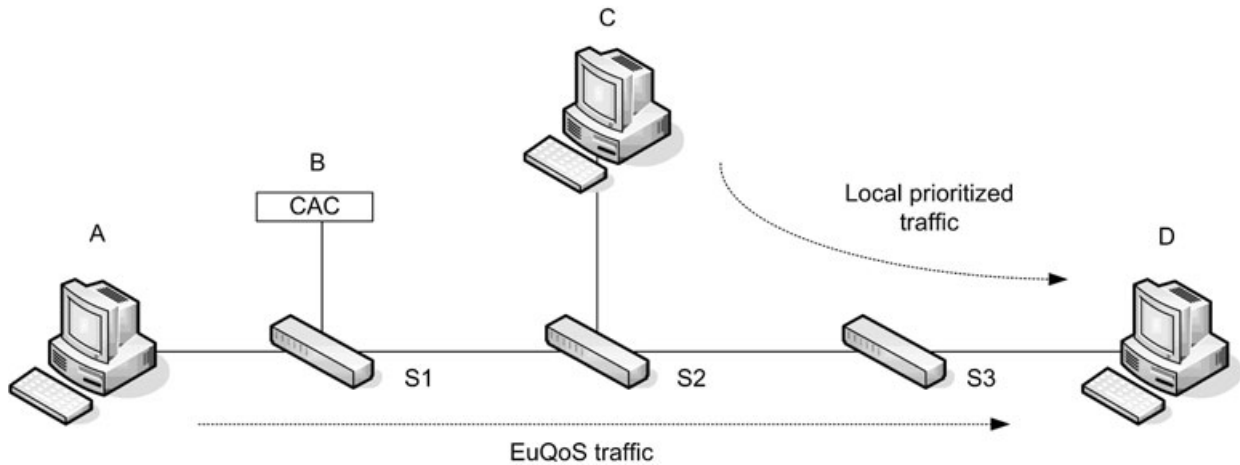

Figure 16. Local prioritized traffic

solution would be consider the use of pieces of software on hosts C and D to re-mark their packets before they get on the network. This solution is inflexible in the way it requires all the hosts to use additional network software. This limitation is even worse for a scenario in which computers are constantly added or removed from the network.

Currently, the EuQoS-aware scenario is being deployed for the EuQoS project platform and improvements are being proposed, such as the use of redundant CAC elements.

## 5. CONCLUSION

One of the major barriers for the employment of an effective resource reservation is the lack of QoS mechanisms on the switches currently available on the market. As a complete solution in admission control is not the aim of this kind of equipment, the solution has to be assembled around it.

Someone can argue that with the popularization of 1- and 10-Gigabit LANs together with some basic QoS mechanisms like 802.1p, a complete QoS solution becomes unnecessary since in such a scenario the network administrator could, with some effort, bring the network to a satisfactory performance even for QoS-sensitive traffic. The authors believe that even in this scenario the proposed QoS solution can represent an improvement in the way the administrator manages network resources, especially in more complex networks.

Also, considerations of security to avoid unauthorized use of LAN resources will be taken into account in the near future.

## ACKNOWLEDGEMENT

This work was partially funded by the European Union 6th Framework Programme under contract project IST-2-004503-IP, EuQoS Integrated Project.

## REFERENCES

1. 802.1Q. *Standards for local and metropolitan area networks, 'Virtual Bridged Local Area Networks'*. IEEE Computer Society, 2003.
2. 802.1D. *Standards for local and metropolitan area networks, 'Media Access Control (MAC) Bridges'*. IEEE Computer Society, 2004.

3. Monteiro E, Boavida F, Simões P, Sá Silva J, Curado M, Cordeiro L, Eugénio R, Carmo M, Zhang J. The use of COPS and NSIS in the EuQoS Project. In *Proceedings of the Conference on Network Control and Engineering for QoS, Security and Mobility (Net-Con'2005)*, France Telecom, Lannion, France, 14–17 November 2005.
4. The Network Simulator. <http://www.isi.edu/nsnam/ns> [September 2006].
5. Almes G, Kalidindi S, Zekauskas M. *A Round-trip Delay Metric for IPPM*. RFC 2681, September 1999.
6. Almes G, Kalidindi S, Zekauskas M. *A One-way Packet Loss Metric for IPPM*. RFC 2680, September 1999.
7. Carmo M, Sá Silva J, Monteiro E, Simões P, Boavida F. Ethernet QoS modeling in emerging scenarios. In *Proceedings of the 3rd International Workshop on Internet Performance, Simulation, Monitoring and Measurement (IPS-MoMe'2005)*, Warsaw, Poland, 14–15 March 2005.

## AUTHORS' BIOGRAPHIES

**Edmundo Monteiro** is Associate Professor at the Department of Informatics Engineering of the Faculty of Sciences and Technology of the University of Coimbra (FCTUC), Portugal. He has a PhD degree in informatics engineering from the University of Coimbra. His main research interests are quality of service in communication systems and network mobility. He is a senior researcher at the Laboratory of Communications and Telematics (LCT) of FCTUC. His publications include three books and over 100 papers in national and international refereed journals and conferences. He has participated in European initiatives and projects such as RARE, TERENA, COST263, FP5 E-NET, FP6 NoE E-NEXT, COST 290, FP6 IP EuQoS, FP6 IP WEIRD, and FP6 SSA OpenNet. He is a member of the Editorial Board of several journals and is involved in the organization of many national and international conferences and workshops. He regularly acts as reviewer of European projects. His home page is at <http://www.dei.uc.pt/~edmund>.

**Jorge Sá Silva** received his PhD in informatics engineering in 2001 from the University of Coimbra, where he is a Professor at the Department of Informatics Engineering of the Faculty of Sciences and Technology of the University of Coimbra, Portugal. His main research interests are Mobility, IPv6, Multicast and Sensor Networks. He is a senior researcher at the Laboratory of Communications and Telematics of DEI. His publications include two book chapters and over 50 papers in refereed national and international conferences. He has participated in European initiatives and projects such as FP5 E-NET, FP6 NoE E-NEXT, FP6 IP EuQoS and FP6 IP WEIRD. He was the Workshop Chair of IFIP Networking 2006 and has also been involved in program committees and the organization of national and international conferences. He is a member of IEEE, and is a licensed Professional Engineer. His home page is at <http://www.dei.uc.pt/~sasilva>.

**Maxweel Silva Carmo** is a PhD student at the Laboratory of Communications and Telematics, University of Coimbra. He has participated on the FP6 EuQoS project and his main interest areas are QoS over Ethernet network technologies and signaling protocols. His home page is at <http://eden.dei.uc.pt/~maxweel>.